

High sensitivity / High speed cameras

HAS-D71 / HAS-D72

Hardware settings user manual

This manual provides safety installation instructions.
Please read this manual thoroughly before using.

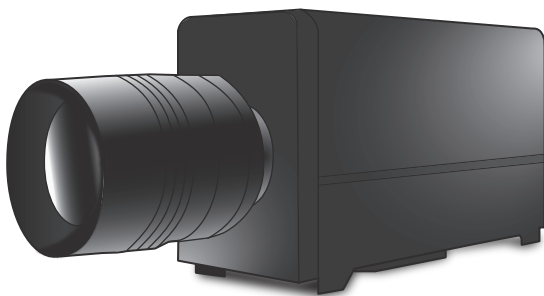

Important safety instructions 3

List of included items 4

Parts names 5

Setting up procedures 6

Connecting to optional accessories 8

Product specifications 10

Support information 10

Table of contents

Important safety instructions	3
List of included items	4
Parts names	5
Setting up procedures	6
Connecting to optional accessories	8
Product specifications	10
Support information	10

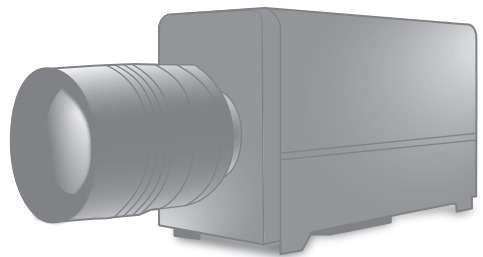

— Introduction —

Thank you very much for your purchase.

Please read this manual thoroughly before installation and operation, and keep this manual for future reference.

— Important safety instructions —

⚠ Caution for safety

- Be aware that while the device is equipped with a cooling fan, the interior components may still be hot.
- Make sure that flammable and combustible materials are not around the device.
- When you are not using the camera, please disconnect the power cable.
- Do not handle plug or appliance with wet hands.
- When plugging or unplugging the cable, ensure that AC power is turned off.
- If your device needs repair, please contact our technical support center.
- Do not disassemble or modify HAS-D71 • HAS-D72.

This device complies with part 15 of the FCC Rules. Operation is subject to the following two conditions: (1) this device may not cause harmful interference, and (2) this device must accept any interference received, including interference that may cause undesired operation.

List of included items

- 1 Camera body
- 2 AC adapter
- 3 USB3.0 cable
- 4 Sync master cable
- 5 Trigger button*
- 6 Software CD
- 7 Sync slave cable*
- 8 External sync cable*
- 9 Battery*
- 10 High brightness LED strobe*

* = optional accessory

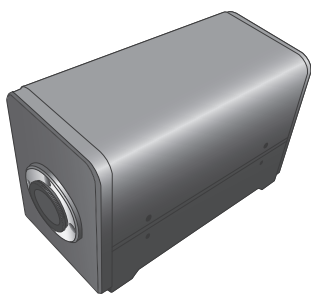

1 Camera body

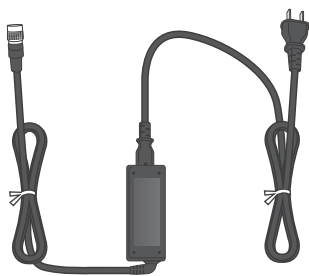

2 AC adapter



3 USB3.0 cable

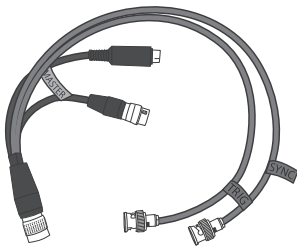

4 Sync master cable
(FST-SYNC-MST-1)



5 Trigger button*
(BNC-SW)

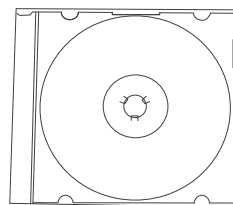

6 Software CD

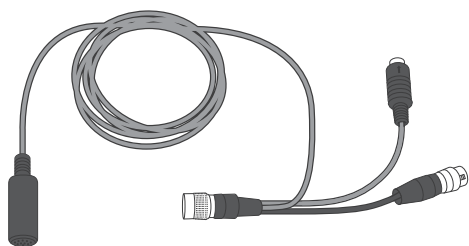

7 Sync slave cable*
(FST-SYNC-SLV)

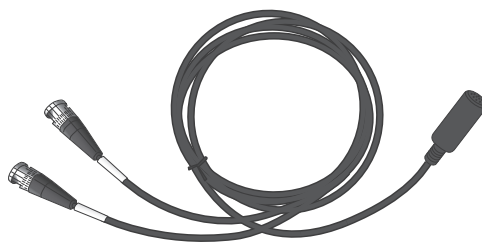

8 External sync cable*
(MD8S-BNCx2)

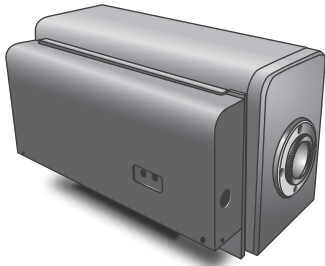

9 Battery*

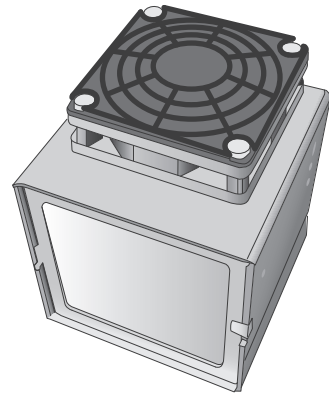

10 High brightness LED strobe*

Parts names

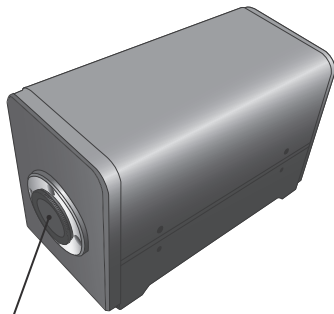

C- mount

1 Front

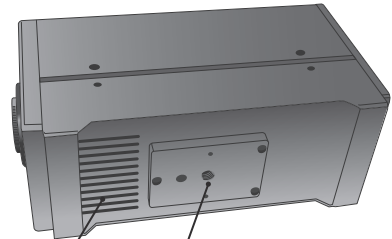

Air vents

Tripod mount

2 Bottom

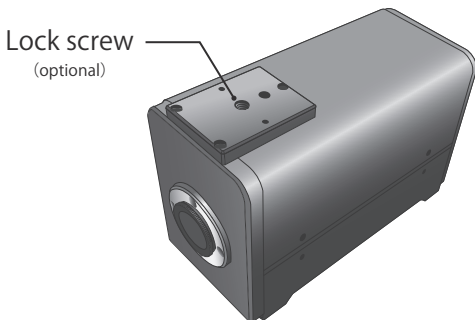

Lock screw
(optional)

3 Top

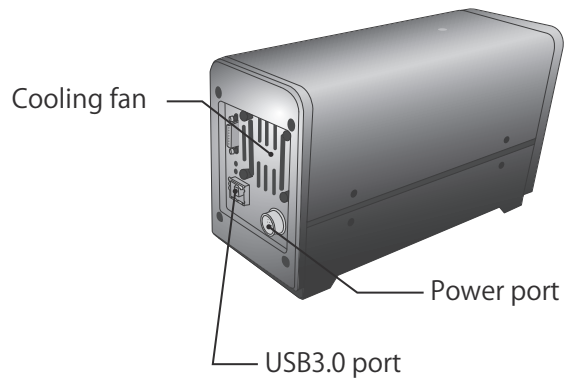

Cooling fan

Power port

USB3.0 port

4 Rear

Setting up procedures

- ① Attach C-mount lens and remove the lens cover.

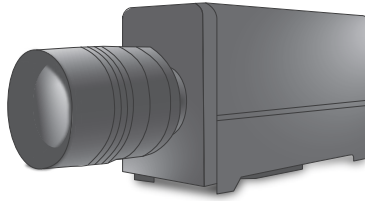

- ② Make sure that the camera is firmly attached to a tripod.

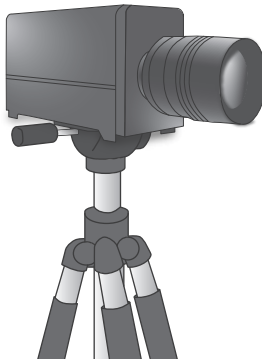

- ③ Connect USB3.0 cable (Standard-B) to the camera.

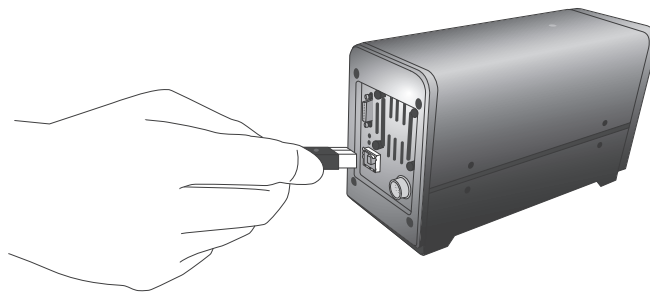

- ④ Connect USB3.0 cable (Standard-A) to your PC.

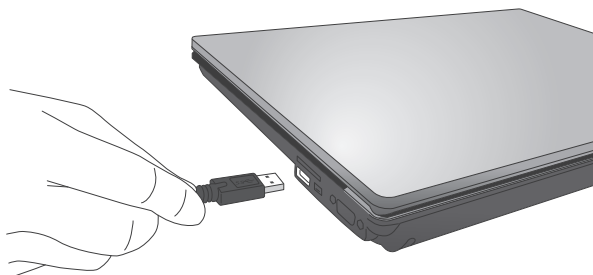

- ⑤ Connect AC adapter to the camera.

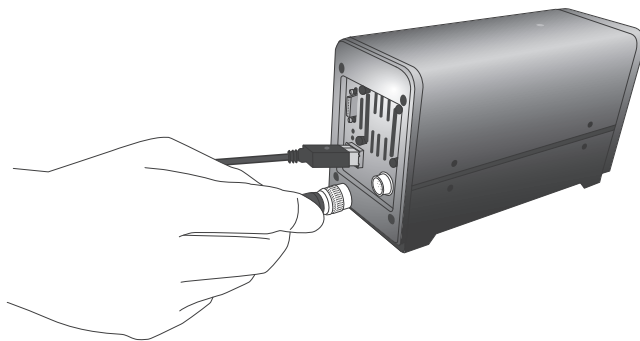

- ⑥ Run the installed application.
※For further assistance, please read the software manual.

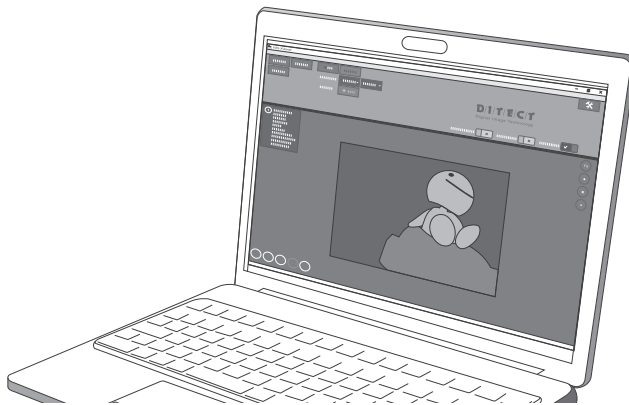

- ⑦ When it is necessary to use an external trigger and / or to synchronize with LED lights, please use a sync trigger cable.

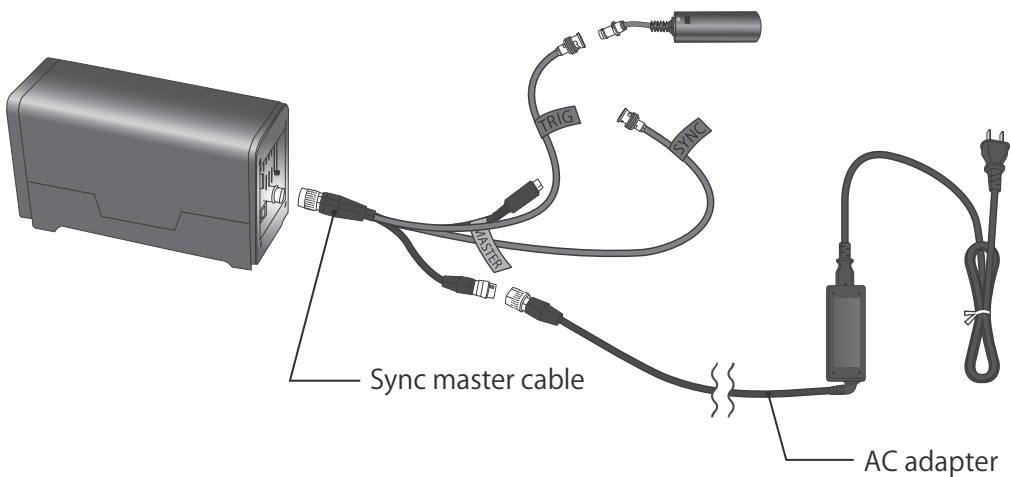

Connecting to optional accessories

1 Trigger button

2 High brightness LED strobe

3 Battery

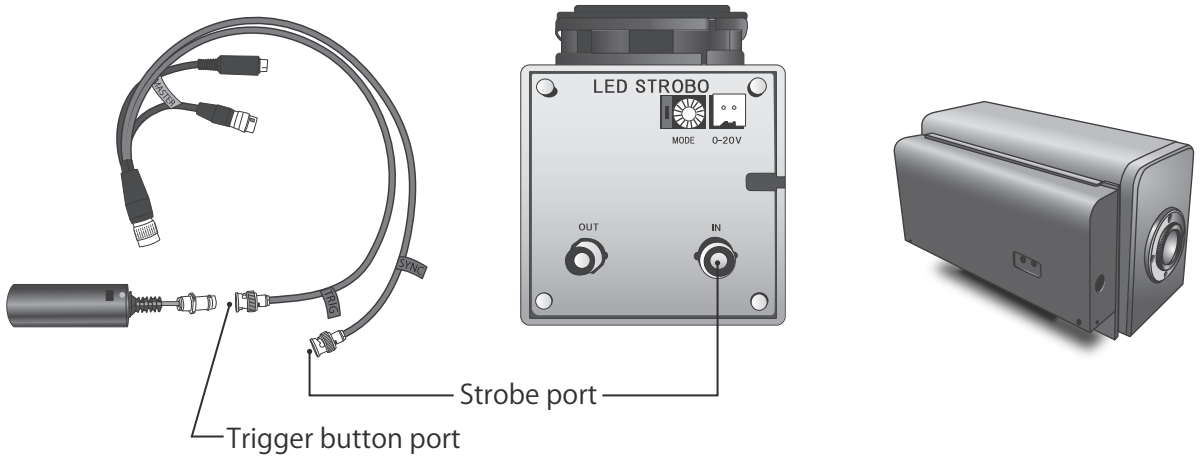

4 Sync slave cable (more than 2 pairs)

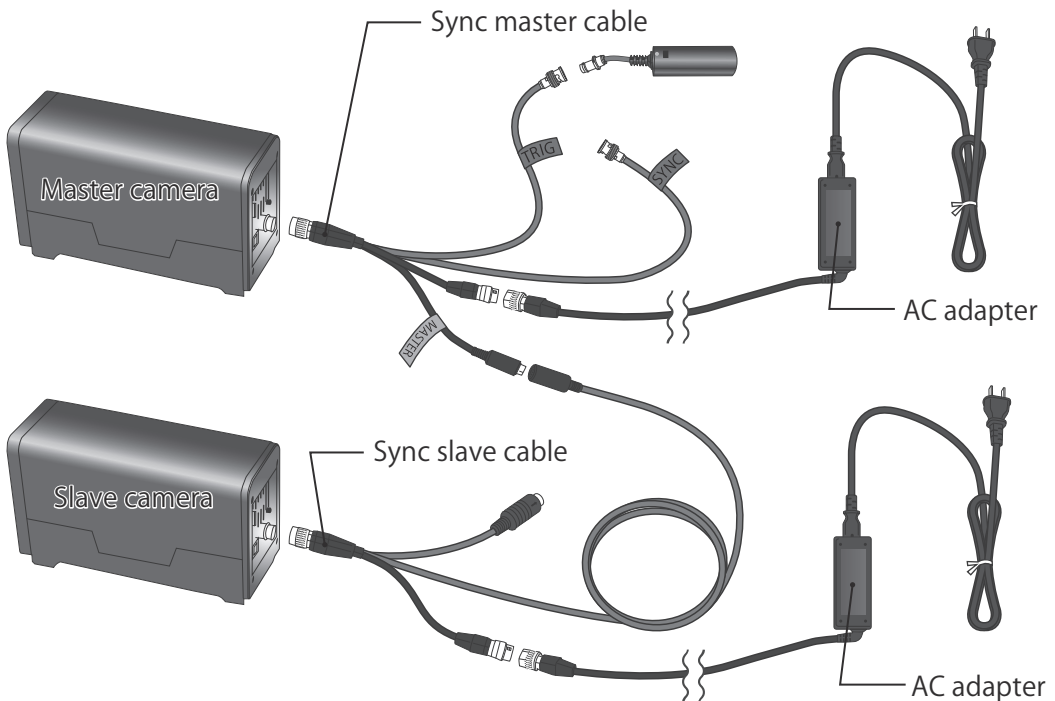

5 External sync cable

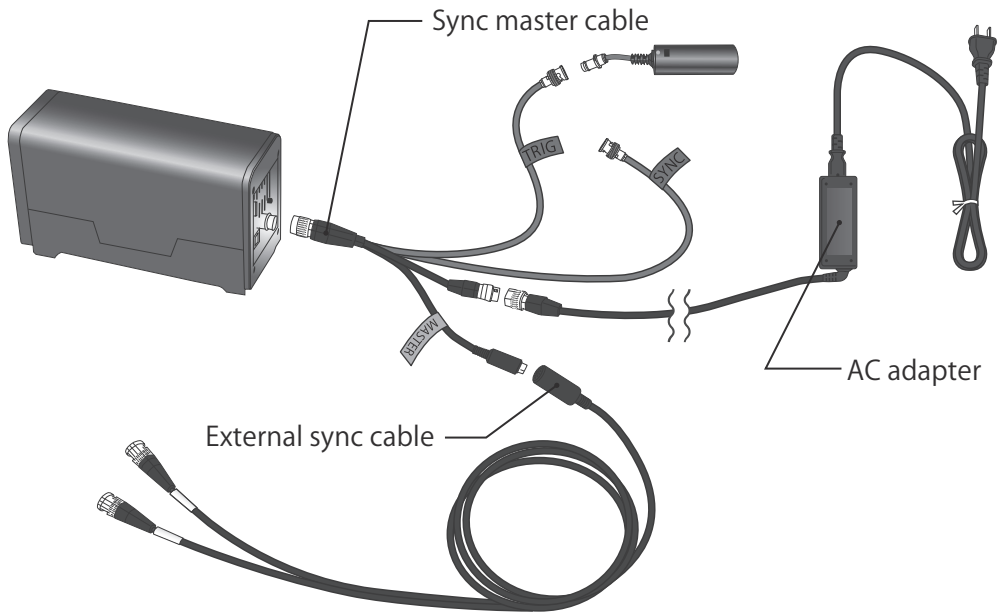

Timing chart

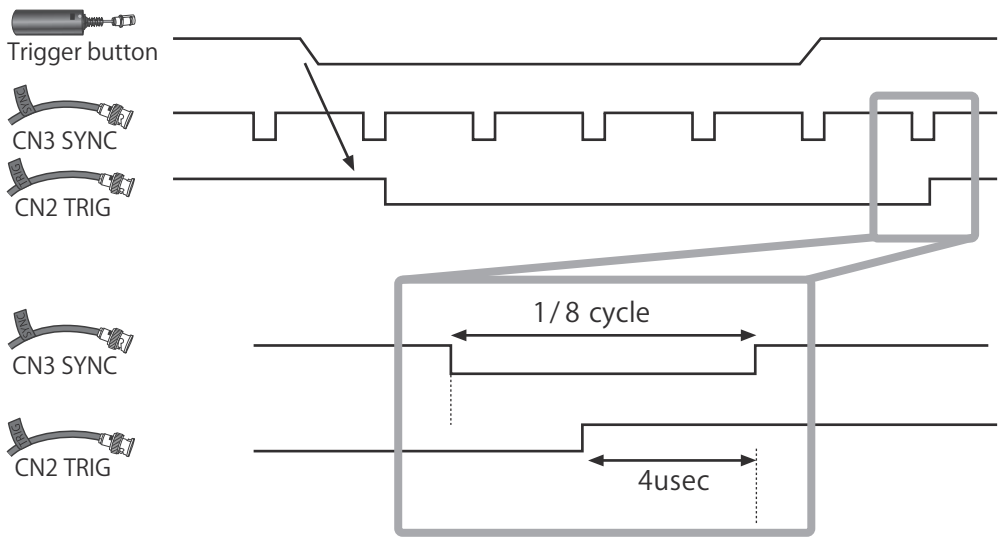

The relationship between sync signal and exposure

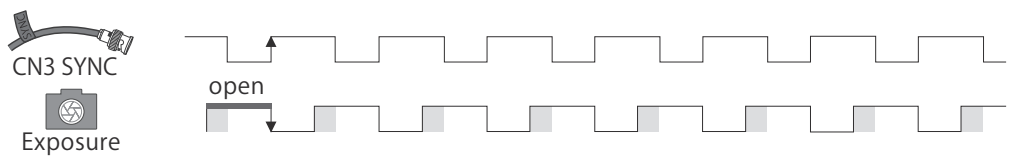

- The exposure ends when HAS-D71 finishes receiving the SYNC signal.
- The exposure time depends on the shutter assigned by your PC.
- Use strobe lights, etc. which are compatible with SYNC3 to control timing.

Product specifications

HAS-D71

	HAS-D71M	HAS-D71C
Camera type	Mono	Color
Sensor	CMOS	
Effective resolution	640 x 480	
Sensor format	1/1.8 inch	
Lens mount	C - mount	
Interface	USB3.0	
Shutter exposure	1usec ~ open	
Sensitivity	38V/lx · s	20V/lx · s
Power supply	DC12V	
Size	73mm × 118mm × 187.4mm	
Electric requirement	24W	
Weight	1.2Kg	
Memory size	Standard 8GB / Extended version 16GB	

Resolution	FPS
640 x 480	8000fps
640 x 240	16000fps
640 x 116	30000fps
640 x 48	60000fps
640 x 12	120000fps

HAS-D72

	HAS-D72M	HAS-D72C
Camera Type	Mono	Color
Sensor	CMOS	
Effective resolution	1280 x 1024	
Sensor format	1/1.8 inch	
Lens mount	C - mount	
Interface	USB3.0	
Shutter exposure	1usec ~ open	
Sensitivity	6.8V/lx · s	3.4V/lx · s
Power supply	DC12V	
Size	73mm × 118mm × 187.4mm	
Electric requirement	24W	
Weight	1.2Kg	
Memory size	Standard 8GB / Extended version 16GB	

Resolution	FPS
1280 x 1024	2000fps
1280 x 480	4000fps
1280 x 240	8000fps
1280 x 120	16000fps

Support information

Please contact our local office for software updates and customized options as well as other inquiries.

*Price, technical specification, and appearance are subject to change without prior notice.

DIRECT corporation

150-0036

1-8 Nampaidai cho, Shibuya ku, Tokyo 150-0036, Japan

TEL : +81-3-5457-1212

E-mail: support@direct.co.jp

URL : <https://www.direct.co.jp/>

DIRECT
Digital Image Technology

High sensitivity / High speed cameras

HAS-D71 / HAS-D72

Hardware settings user manual Rev1.0.4

D/I/T/E/C/T
Digital Image Technology