

BL2.8/12-19

Specifications

Part Number	B190512	HH'	29.42mm
Focal Length	12mm	Mount	C-Mount
Image Circle	19.2mm	MaxD	Φ40
Max. F#	F2.8	Filter	/
Magnification	0.0-0.07	Σd	54.87mm
Spectrum	420nm - 680nm	A'	2.3mm
Working Distance	150mm-∞	A'f	12.53mm-17.55mm
Resolution	2.74 μm		

Mechanical Drawing

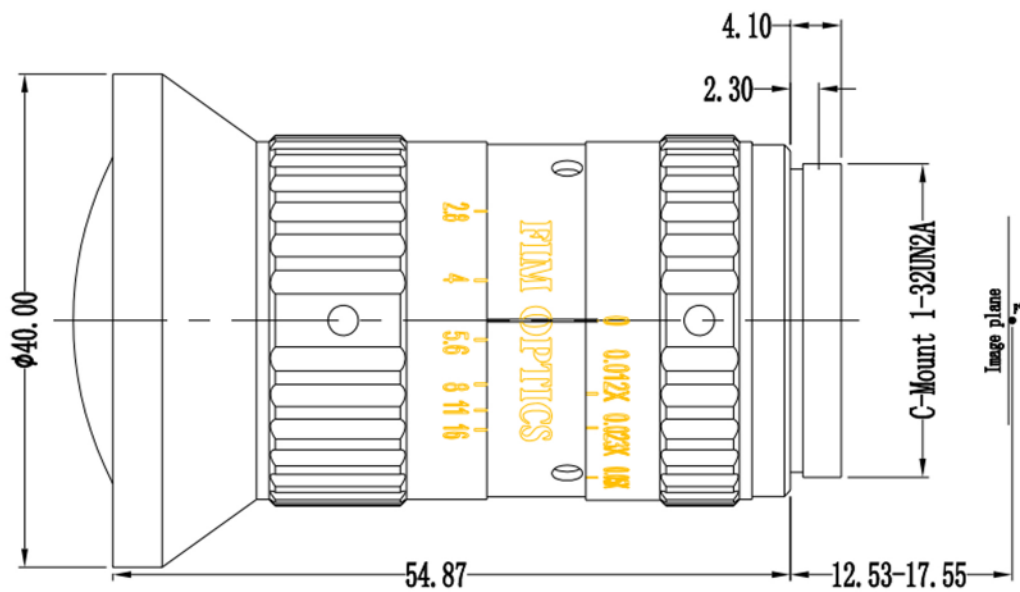

Distortion

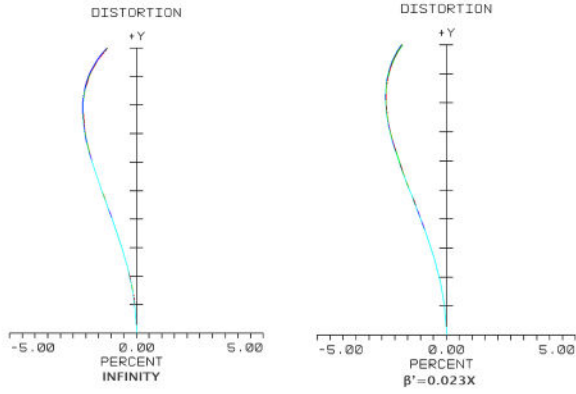

Field Curvature

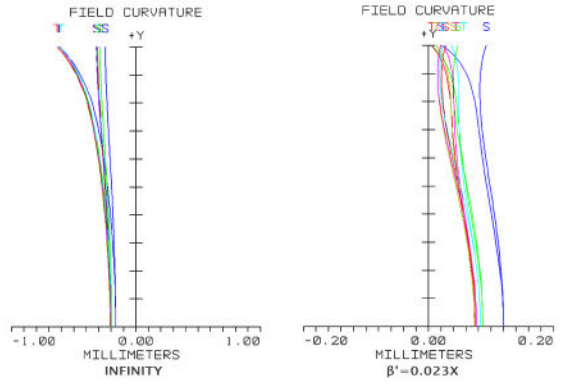

Modulation to Relative Image Height

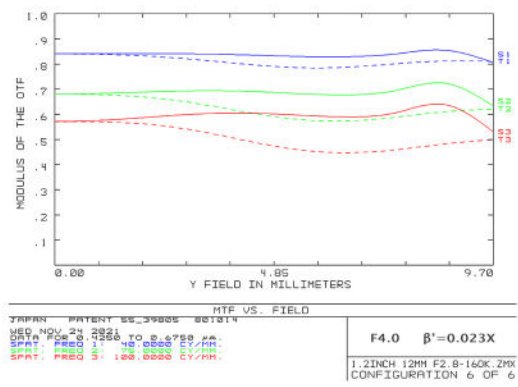
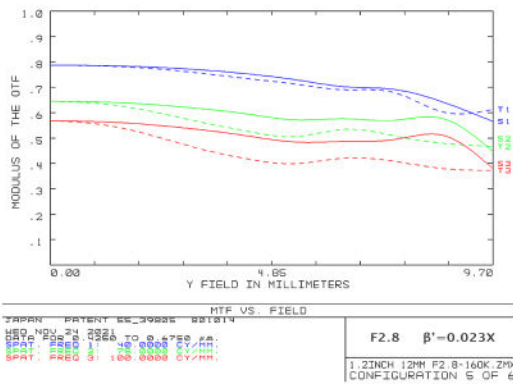

Relative Illumination

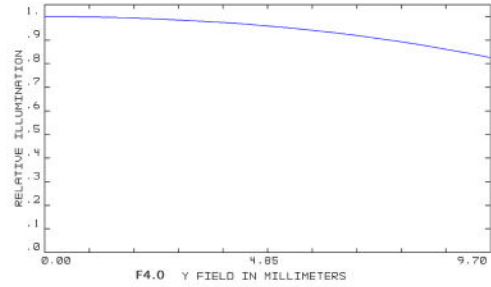
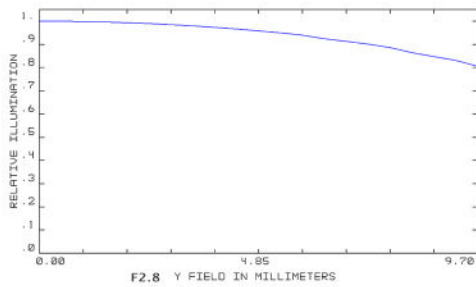

Transmittance

