

BL2.4/8-19

Specifications

Part Number	B190508		
Focal Length	8.3mm	HH'	62.47mm
Image Circle	19.2mm	Mount	C-Mount
Max. F#	F2.4	MaxD	Φ68
Magnification	0.0-0.25	Filter	M66×0.5
Spectrum	400-700	Σd	82.46mm
Working Distance	13mm-∞	A'	-2.30mm-0
Resolution	2.74 μm	A'f	15.17-17.92mm

Mechanical Drawing

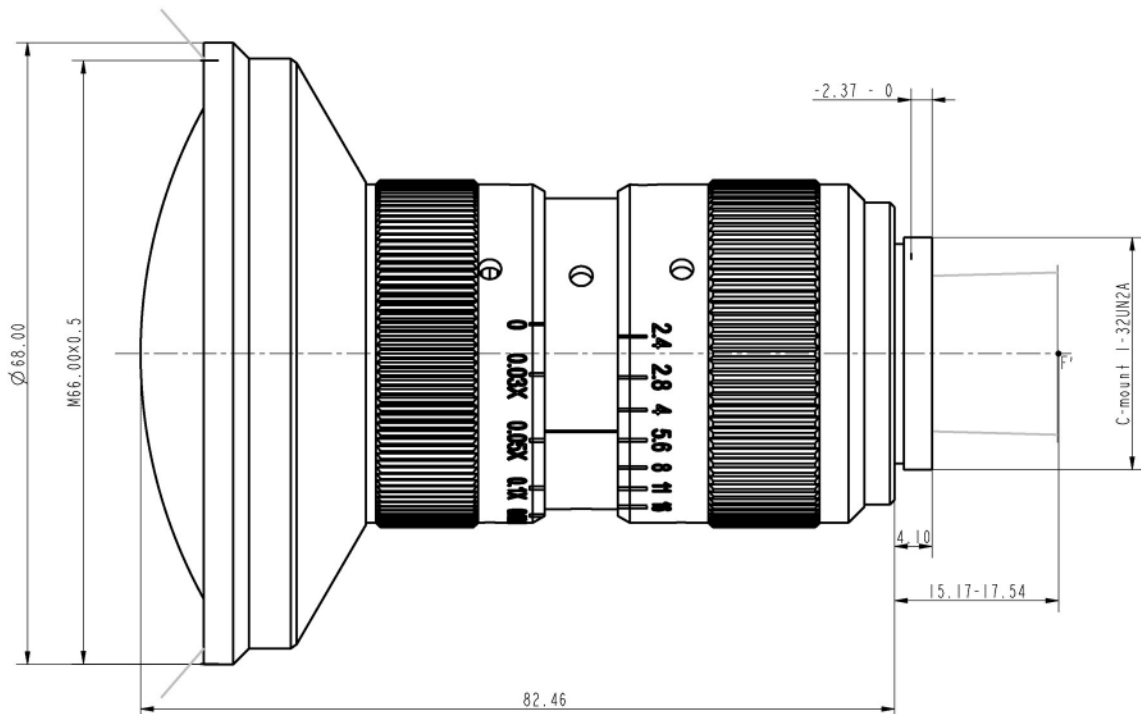

Distortion

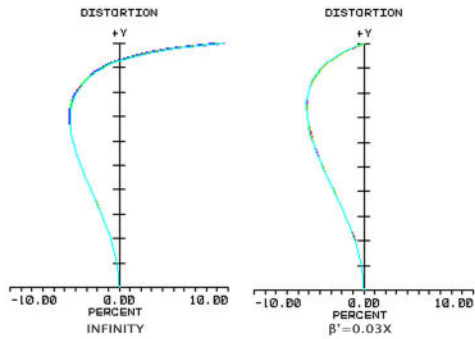

Field Curvature

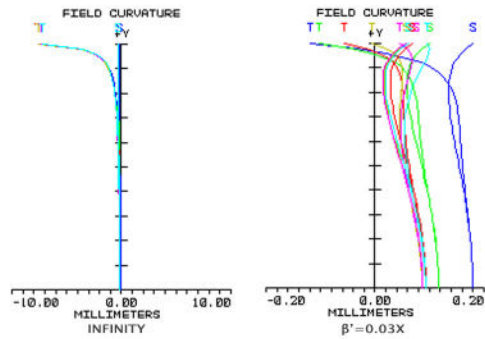

Modulation to Relative Image Height

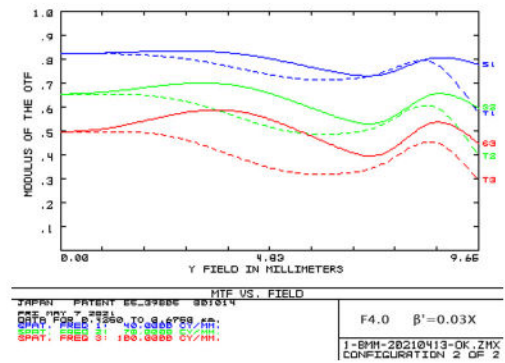
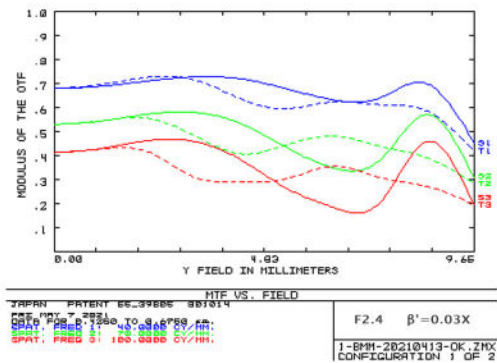

Relative Illumination

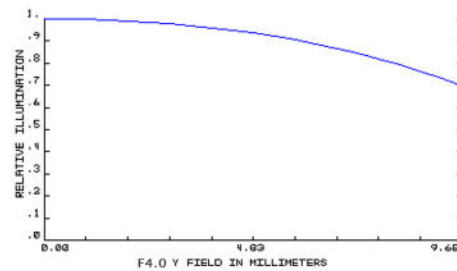
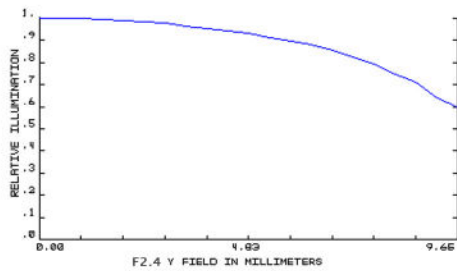

Transmittance

