

High Illuminance Line Scan Lights SBS-LSLHI series

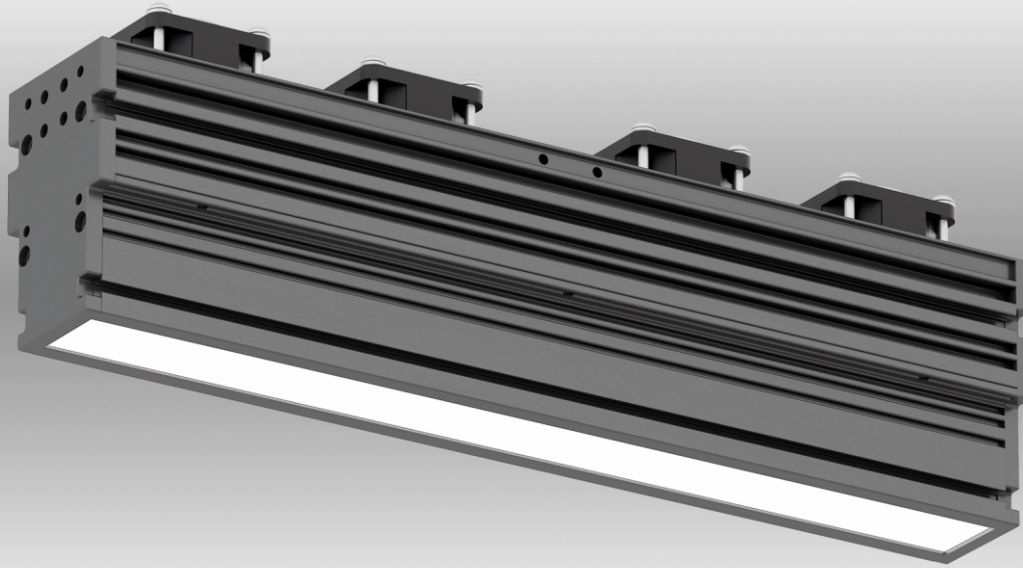

Products Features

- ▶ Using high power LEDs.
- ▶ LWD can be 50~200mm.
- ▶ Illuminance can be three million lux.

Applications the light be used for

- Printing material defects inspection.
- LCD surface defects inspection.
- PCB solder joint and defects inspection.
- Parts at the bottom of the car defects inspection.

Model Description

SBS-LSLHI-XXX-X

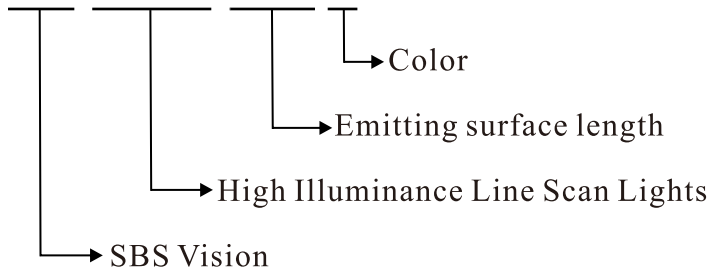

Customization

- Length
- Mounting
- Cable length
- Power
- Color

Standard Line Scan Lights Illumination



Components

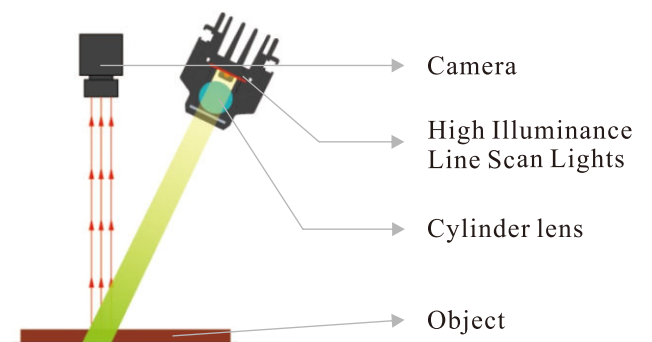

Parameter

Item	Model	Power consumpition White Color	WD (mm)	Emitting surface (mm)	Dimension (L*W*H) (mm)	Recommended Controller
1	SBS-LSLHI300	48V/110.2W	50~100	300*25	310*50*88	SBS-DCHP48-X
2	SBS-LSLHIL300	48V/110.2W	100~200	300*25	310*50*88	

LWD VS Illuminance

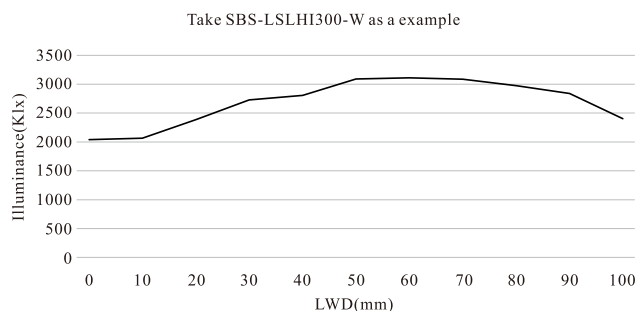

Measure value at 100% intensity in each LWD, results may vary.

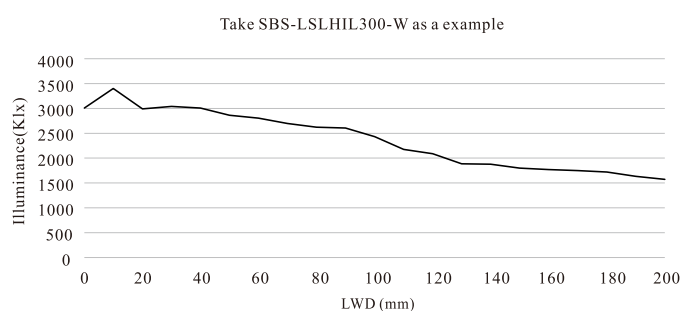

Measure value at 100% intensity in each LWD, results may vary.

Uniformity

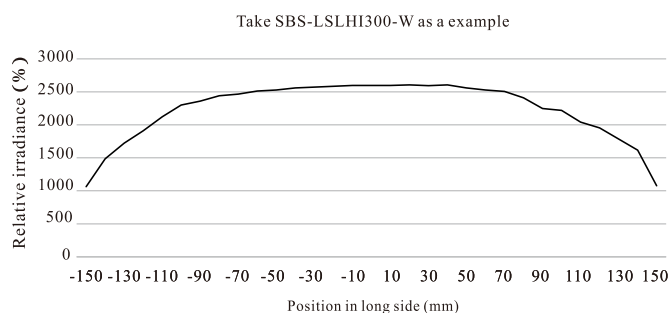

Measure value at 100% intensity in the LWD of 100mm, results may vary.

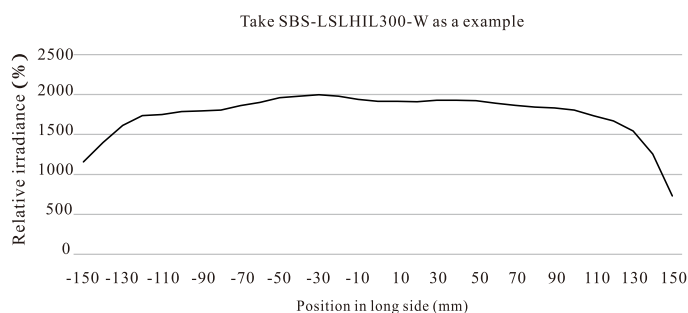

Measure value at 100% intensity in the LWD of 100mm, results may vary.

Dimensions(mm)

