

BL 2.4/8-11-U

Specifications

Part Number	U110108	HH'	35.556mm
Focal Length	8.1mm	Mount	C-Mount
Image Circle	11mm	MaxD	Φ33.50
Max. F#	F2.4	Filter	M30.5×0.5
Magnification	0.0 - 0.25	Σd	49.79mm
Spectrum	420nm - 680nm	A'	4.81mm - 7.09mm
Working Distance	21mm - ∞	A'f	15.33mm - 17.61mm
Resolution	3.45 μm		

Mechanical Drawing

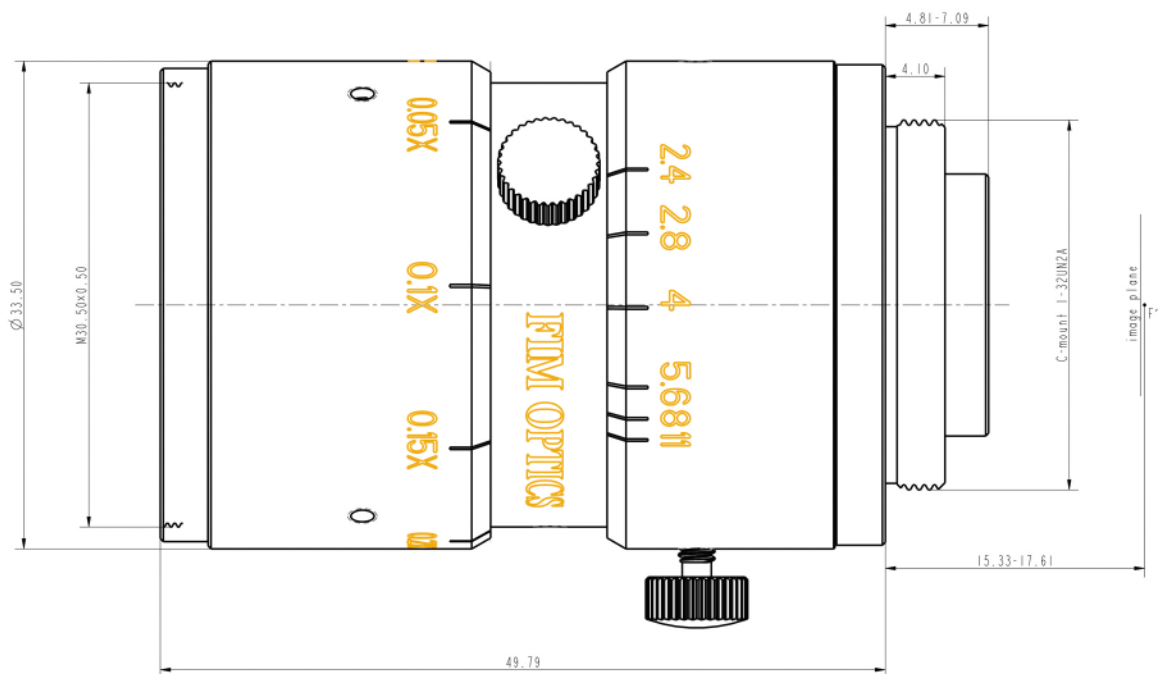

Distortion

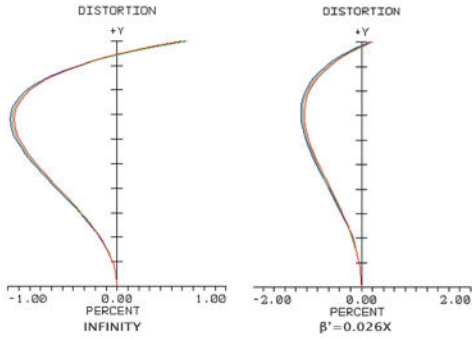

Field Curvature

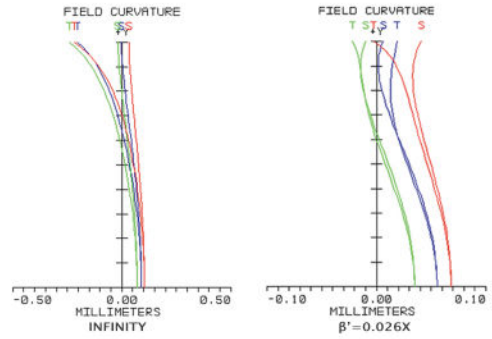

Modulation to Relative Image Height

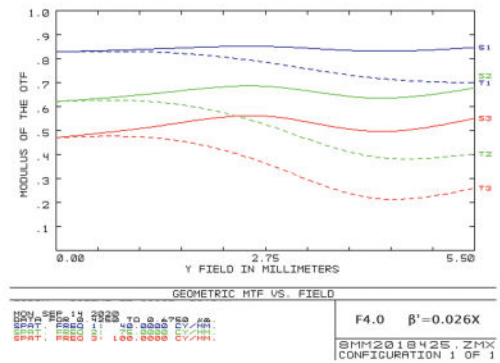
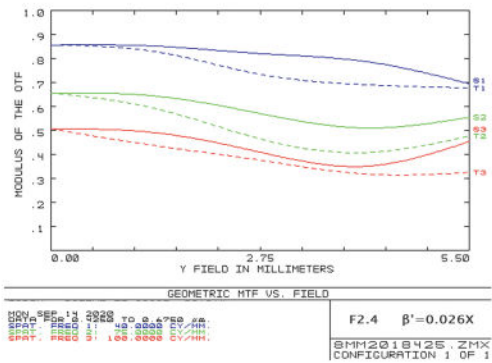

Relative Illumination

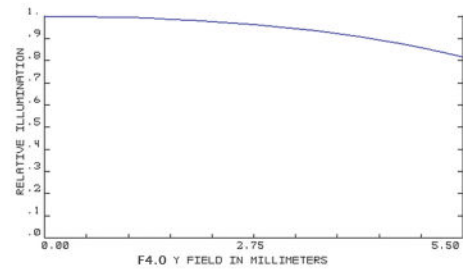
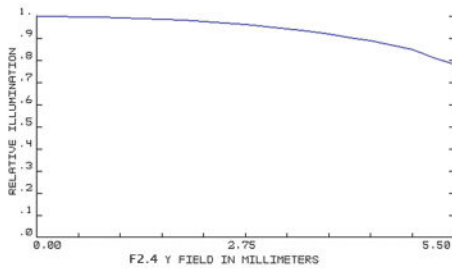

Transmittance

