

# BL2.4/50-19

## Specifications

Part Number	B190550	HH'	-3.65mm
Focal Length	50mm	Mount	C-Mount
Image Circle	19.2mm	MaxD	Φ46
Max. F#	F2.4	Filter	M39×0.5
Magnification	0.0-0.25	Σd	52.81mm
Spectrum	400nm - 710nm	A'	-3.46mm-8.87mm
Working Distance	214mm-∞	A'f	5.22mm-17.55mm
Resolution	2.74 μm		

## Mechanical Drawing

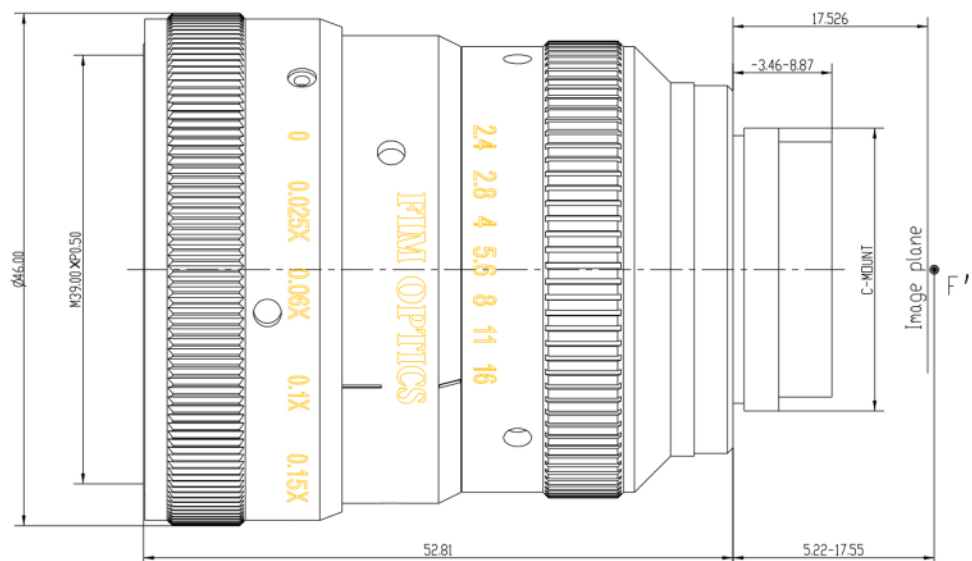

## Distortion

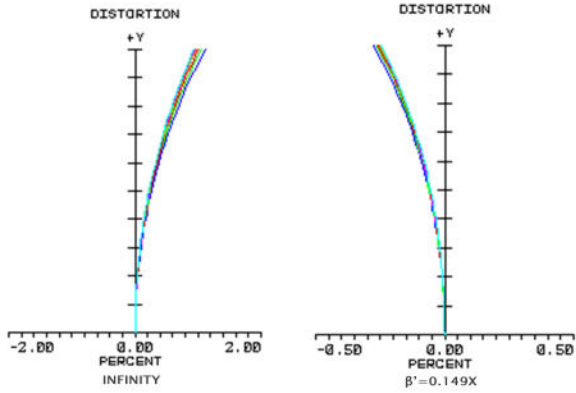

## Field Curvature

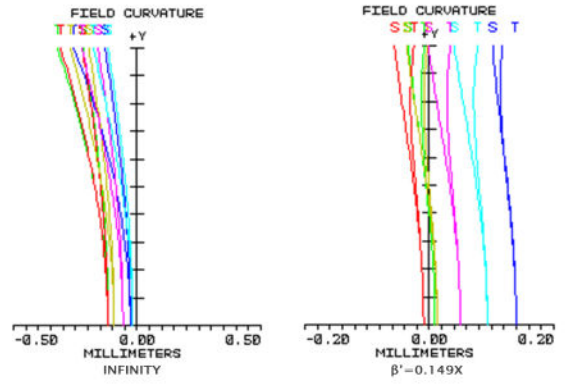

## Modulation to Relative Image Height

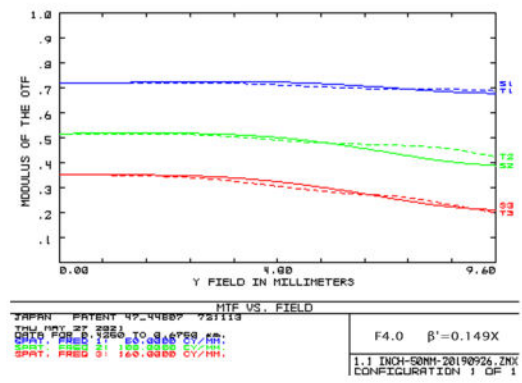
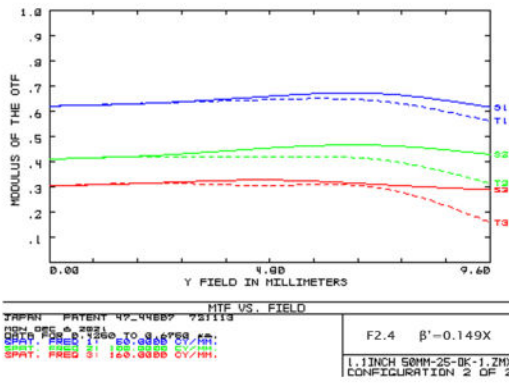

## Relative Illumination

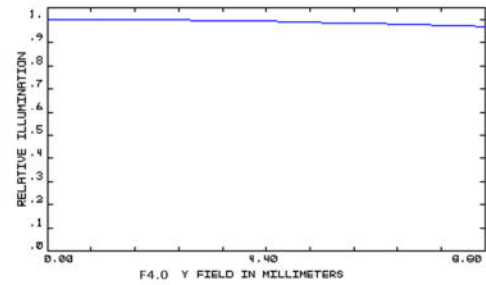
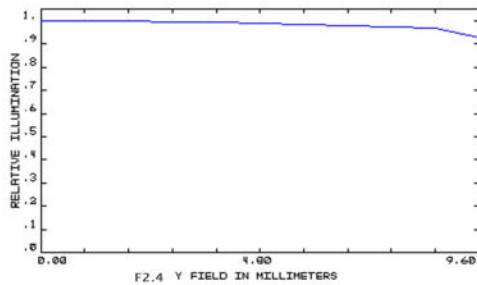

## Transmittance

